

Flow meters



More than just pumps



About FLUX

FLUX pump technology – the right solution even for demanding fluids



More than just pumps

One brand. One promise.

The FLUX name has been synonymous with pump technology for more than 60 years. It was the invention of the electric drum pump that sparked it all off. In the meantime, of course, the technology has become more sophisticated. FLUX company innovations have markedly improved working routines for filling and transferring fluids.

It is often said that medium-sized companies are the engines of progress. We would be pleased if our family business were able to substantiate this claim.

When you choose FLUX you are making a good decision for the long term. With our products we want to assist you to save time and money and by the way – spare your nerves as well. We are therefore delighted when you discuss your requirements with us.

Warmly

A handwritten signature in black ink, appearing to read "K. Hahn".

Klaus Hahn,
CEO FLUX-GERÄTE GMBH

Pumping, emptying, mixing, filling and metering – when liquids are set in motion the requirements are very diverse. In any case the process must run smoothly. This is what the FLUX brand name stands for. It is recognised across the globe as a byword for quality, for safety and for solutions which are able to fulfil every single demand on a long-term basis.

Smooth-running processes – FLUX not only guarantees this for liquids which are easy to pump but also when the pumping medium is viscous or doesn't flow at all, when it is aggressive or used in processes which are common in the hygiene sector or sectors where there is an explosion hazard. To ensure that the tasks are solved in the best possible way for the customer FLUX has a huge range of expertise to offer. In other words, a lot more than just pumps. From a technical point of view this means a comprehensive product range of pumps, motors, flow meters, accessories and a whole lot more. From a project point of view, "More than just pumps", means accompanying our customers from the first telephone call through to the end solution – and if required beyond that.

This is how FLUX keeps processes moving. Long-term. Simple, complex or custom-made inclusive design assignments: FLUX is prepared for any request and in particular for the fact that our customers need more than just pumps.



The worldwide first electrical drum pump

Quality

The brand name FLUX is a quality promise to our customers. They rightly trust that they always receive the best quality from us.

- ▶ **Reliability.** In concrete terms: Every minute of downtime is a minute too much. FLUX strives to prevent downtimes in the best way possible.
- ▶ **Long service life.** The construction which has been thought through into every detail ensures long-term reliability even under the most severe operating conditions.
- ▶ **Made in Germany.** FLUX has its central production location in Maulbronn, Baden-Württemberg.
- ▶ **Awards.** Such as the iF Product Design award which FLUX brand products have won several times underline the unique claim of the FLUX brand.



Own injection moulding production, here for the housing of an FMC.



Complete assembly of the flow meter FMC / FMJ is done in the house of FLUX with specially prepared assembly directions.



Each flow meter is checked and calibrated - 100 % quality control!

Milestones in flow meter technology at FLUX

- ▶ **1960:** Introduction of the first flow meter series FM built to cylindrical piston principle
- ▶ **1979:** Introduction of FM series built to the nutating disc principle
- ▶ **1991:** Introduction of FMC series built to the nutating disc principle
- ▶ **2000:** Introduction of FMJ series built to the nutating disc principle
- ▶ **2008:** Introduction of FMT series built to the turbine wheel principle
- ▶ **2011:** Introduction of FMC/FMJ with evaluation unit FLUXTRONIC®
- ▶ **2015:** Introduction of new flow meter series FMO built to the oval rotor principle
- ▶ **2015:** Bearing flange with pulse generator for indirect volume measurement



Manual filling with drum pump and FM cylindrical piston meter in 1960.



FMO 110 from the new introduced FMO series built to the oval rotor principle.

Table of contents

Overview

Industries, certificates, conformities	05
Indirect volume measurement	06
Direct volume measurement	07
General information about flow meters	08
Overview flow meters	10
Flow meter FMC/FMJ	12
Flow meter FMO	14
Evaluation unit FLUXTRONIC®	16
Flow meters FMC and FMO as part of semi-automatic filling systems	18
Flow meter FMT 120 PP	20
Customized all-in solutions	21
Accessories for flow meters	22

Industries, certificates and conformities

The right solution for every industry



With its application-based products FLUX has the right solution for every sector of industry. Use our icons as a guide to help you to find the products which are suitable for your industry.



Chemical



Industry



Surface technology



Paints and lacquers



Food



Petrochemicals



Cosmetics



Pharmaceuticals



Water treatment





Agriculture

Certified safety for the most widest range of industries and countries: FLUX products have been developed and certified for use around the world; they comply with the highest demands and safety standards. With FLUX you are always on the safe side everywhere.

All FLUX products conform to pertinent fundamental health and safety regulations of the EC Machinery Directive 2006/42/EC and are therefore CE certified.



Furthermore, selected FLUX products are available with the following certificates:

<p>For use in hazardous areas FLUX products with explosion protection are available which are built and certified in accordance with ATEX Directive 2014/34/EU.</p>	
<p>FLUX Products with 3A certification and FLUX FOOD For use in pharmaceutical and food sector there are FLUX products which are acc. to EC 1935/2004 for contact with food or conform FDA CFR 21.</p>	 

Bearing flange with impulse generator

for indirect volume measurement



Advantages/characteristics

- ▶ Allows indirect volume measurement to be taken without contact with the material
- ▶ Especially for eccentric worm-drive pumps series F 550 and F 560 with bearing flange
- ▶ Theoretical accuracy +/- 1 pulse per measurement
- ▶ Also for use in the Pharma, Food and Cosmetic industry
- ▶ Also for use with the drum emptying system VISCOFLUX mobile S
- ▶ Suitable in all cases where frequent cleaning is essential
- ▶ Media examples: grease, tomato paste, vaseline, crème caramel, polymer latex
- ▶ Combined with FLUXTRONIC® + amplifier, control unit or PLC-batch processing possible
- ▶ Protection class IP 65

Technical data

Connection outer tube F 550	G 2
Connection outer tube F 560	Rd 65 x 1/6
Ø bearing flange	160 mm
Pulse cable	5 m
Protection class	IP 54
Connection bearing flange	4-pole cable connector CA3 LS
Connection e.g. on control unit	5-pole connector
REED-sensor	Magnetically actuated
Number of pulses per revolution	4

Volume per impulse

Eccentric worm Ø 21	0,0075 l
Eccentric worm Ø 26	0,0125 l

Material

Housing	Stainless steel (1.4301)
---------	--------------------------

Functional description

The bearing flange with impulse generator gives 4 pulses per turn of the shaft. The magnets installed at the coupling switch a reed switch which can be evaluated.

Pulse transmission possible to:

Electronic analysis unit FLUXTRONIC®	Control unit (with integrated PLC)	Existing control (e.g. PLC)
<ul style="list-style-type: none"> ▶ For wall mounting ▶ Medium calibration possible ▶ Display of transferred quantity (normal mode) ▶ With switching amplifiers batch filling possible (automatic mode) 	<ul style="list-style-type: none"> ▶ E.g. for use with VISCOFLUX mobile S ▶ Available with integrated FLUXTRONIC® ▶ Speed regulation possible ▶ Also for pumps with clockwise/anti-clockwise rotation 	<ul style="list-style-type: none"> ▶ For external control ▶ Can be networked with other IT systems ▶ For complex applications ▶ Use of existing control systems possible



The bearing flange with impulse generator enables an indirect volume measurement.

FLUX flow meters

for direct volume measurement



For quality assurance, ecological and economic reasons, the requirements for safety and control in industry increase constantly. When it comes to liquids handling, industry is concerned with ensuring absolute safety combined with maximum measurement accuracy. FLUX flow meters meet these concerns and criteria. Their versatility and operating

simplicity make child's play of measuring operations. Whether in stationary or flexible use with drum and container pumps or in plant engineering, whether with thin, pure, low-viscosity to high-viscosity media, our flow meters work safely and enable a successful process control.

Nutating disc principle

The flow meters FMC/FMJ work on the nutating disc principle. Here the liquid flow makes the nutating disc move. The evaluation unit FLUXTRONIC® calculates the filled quantity from the number of rotations. For maximum measuring accuracy the system must always be completely filled with liquid (full hose system).





- ▶ Use of the FMC/FMJ flow meters mainly with our drum and container pumps of the 400 series
- ▶ Also for stationary use in plant engineering
- ▶ Use of FMJ only when no batch operation is necessary
- ▶ Suitable for low-viscosity media
- ▶ Also for applications in hazardous areas 

Oval rotor principle

The flow meters FMO consist of a measuring chamber with oval rotors. The fluid runs through the measuring chamber and thus drives the oval rotors. With a REED sensor the number of rotations is counted and passed to the external FLUXTRONIC®. This calculates the flow quantity of the fluid on the basis of a previously given, medium dependent calibration constant.



- ▶ Use of the flow meters FMO 101 and 102 for small flow rates
- ▶ Flow meters FMO 104 and 110 are mainly used with our drum and container pumps as well as eccentric worm drive pumps
- ▶ Flow meters FMO 140 and 150 are mainly used in larger plants
- ▶ Suitable for pure and thin to high-viscosity media
- ▶ Also for use in hazardous areas
- ▶ Also with FDA/Food approval  

Turbine wheel principle

The turbine meter FMT 120 PP consists mainly of a turbine wheel freely rotating in the liquid flow. The medium flowing in the flow meter makes the turbine wheel turn, this is measured and evaluated. The evaluation of the partial and total quantity is made via the LCD display.



- ▶ Use of flow meter FMT mainly with our JUNIORFLUX/COMBIFLUX pumps
- ▶ Low-cost alternative to our FMC/FMJ flow meters
- ▶ Suitable for pure, low-viscosity media

FLUX flow meters

Good to know when selecting the flow meter type

Connections

Flow meter type	Standard connections (inlet-outlet)
FMC 100	For plastic versions G 1¼ - G 1¼ A G 1½ A - G 1½ A For stainless steel version G 1½ A - G 1¼ A Rd 65 x 1/6 - Rd 65 x 1/6 G 1 - G 1 Flange PN 10/DN 25 - PN 10/DN 25*
FMC 250	G 2¼ A - G 2¼ A
FMJ 100	G 2 A - G 1¼ A
FMO 101/102	G ¼ - G ¼
FMO 104	G ½ - G ½
FMO 110	G 1 - G 1, in stainless-steel version also with Clamp 1½ and Clamp 2
FMO 140	Flange DIN 1092 PN 16/DN 40 - PN 16/DN 40**
FMO 150	Flange DIN 1092 PN 16/DN 50 - PN 16/DN 50***
FMT 50 PP	G 1 A - G 1 A G 1¼ - G 1 A

* Flange dimension: Outer ø 115 mm, pitch circle ø 85 mm, 4 holes ø 14 mm

** Flange dimension: Outer ø 150 mm, pitch circle ø 110 mm, 4 holes ø 18 mm

*** Flange dimension: Outer ø 165 mm, pitch circle ø 125 mm, 4 holes ø 18 mm

Material combinations of different flow meter types

Material	Flow meter types																
	FMC 100			FMC 250		FMJ 100	FMO 101/102			FMO 104		FMO 110			FMO 140/150		FMT 50 PP
Housing	PP	S	ETFE	PP	PVDF	PP	S	PVDF	S	AL	S	AL	PVDF	S	AL	PP	
Measuring chamber cpl. or impellers	S	-	-	-	-	-	-	X	X	X	-	X	-	-	X	-	-
	PP	-	-	-	-	-	-	-	-	-	-	-	-	-	-	-	X
	PPS	X	X	-	-	-	X	-	X	X	X	X	X	X	X	X	-
	ETFE	-	-	X	-	-	-	-	-	-	-	-	-	-	-	-	-
	PE	-	-	-	X	-	-	-	-	-	-	-	-	-	-	-	-
	PVDF	-	-	-	-	X	-	-	-	-	-	-	-	-	-	-	-
Seals	EPDM	X	X	X	X	X	-	X	X	X	X	X	X	X	X	X	-
	FKM	X	X	X	X	X	X	X	X	X	X	X	X	X	X	X	X
	FEP	X	X	-	-	-	-	-	-	-	-	-	-	-	-	-	-
	FFKM	-	-	X	-	-	-	X	X	X	X	X	X	X	X	X	-

Note

In the housing of the flow meters FMC/FMJ a measuring chamber is installed in which the nutating disc is moving. Measuring chamber and nutating disc are therefore called measuring chamber cpl.

With the flow meters FMO/FMT the housing parts form a measuring chamber in which the oval rotors (FMO) resp. a turbine wheel (FMT) act as impellers.

Construction materials

Material (j)*	Characteristics
Stainless steel (S)	<ul style="list-style-type: none"> ▶ Used for housings, oval rotors and shafts ▶ For all neutral, not flammable media as well as flammable media, acids and alkalis, solvents and typically for food, cosmetics and pharmacy ▶ Used in hazardous areas ▶ Operating temperature range up to approx. 120 °C
Hastelloy C (HC)	<ul style="list-style-type: none"> ▶ Used for shafts ▶ For highly flammable media, strong acids and alkalis as well as very aggressive media ▶ Used in hazardous areas if the chemical resistance of stainless steel is not sufficient ▶ Operating temperature range up to approx. 120 °C
Aluminium (AL)	<ul style="list-style-type: none"> ▶ Used for housings ▶ Mostly for oils (diesel, hydraulic oil), drilling emulsions, but also for neutral, hardly flammable media ▶ Used in hazardous areas ▶ Operating temperature range up to approx. 80 °C
Polypropylene (PP)	<ul style="list-style-type: none"> ▶ Thermoplastic plastic with a very good chemical resistance range ▶ Used for housings and turbine rotor ▶ For acids, alkalis and neutral, not flammable liquids ▶ Used in hazardous areas ▶ Operating temperature range up to approx. 60 °C
Polyvinylidene fluoride (PVDF)	<ul style="list-style-type: none"> ▶ Thermoplastic fluoroplastic with outstanding chemical resistance ▶ Used for housings and measuring chamber cpl. ▶ For concentrated acids and neutral, non-flammable liquids ▶ Operating temperature range up to approx. 60 °C
Polyphenylene sulphide (PPS)	<ul style="list-style-type: none"> ▶ Partially crystalline high-performance material with a very high chemical resistance ▶ Used for measuring chamber cpl. and oval rotors ▶ For almost all solvents, many acids and alkalis ▶ Used in hazardous areas ▶ Operating temperature range up to approx. 200 °C
Ethylene-tetrafluoroethylene (ETFE)	<ul style="list-style-type: none"> ▶ Fluorine-based plastic, that convinces with its high chemical resistance ▶ Used for measuring chamber cpl. and oval rotors ▶ For acids, alkalis and neutral, not-flammable liquids ▶ Used in hazardous areas ▶ Operating temperature range up to approx. 80 °C









Seal materials

Material (j)*	Characteristics
EPDM (0)	<ul style="list-style-type: none"> ▶ Ethylene-Propylene-Diene-Monomer ▶ Good resistance against alkalis and some solvents ▶ Not resistant against fuels, oils or solvents ▶ In combination with flow meters in PP, AL, PVDF, ETFE and stainless steel
FKM (1)	<ul style="list-style-type: none"> ▶ Fluoro rubber ▶ Good resistance against acids and alkalis as well as many solvents ▶ In combination with flow meter in PP, AL, PVDF, ETFE and stainless steel
FFKM (2)	<ul style="list-style-type: none"> ▶ Perfluororubber type M ▶ Very good resistance against acids and alkalis as well as almost all solvents ▶ In combination with flow meters in PP, AL, PVDF, ETFE and stainless steel
FEP (3)	<ul style="list-style-type: none"> ▶ Perfluoroethylene propylene ▶ Very good chemical resistance against most liquids and chemicals ▶ FEP coated O-ring consists of a rubbery-elastic inner ring and an FEP coat which seamlessly encloses the O-ring ▶ In combination with flow meter in stainless steel, PP

* Material code or number for use in type designation

Overview of flow meters

Quick and easy to select the right flow meter for your requirement

Flow meter type	Nutating disc principle			Oval rotor principle	
	FMC 100	FMC 250	FMJ 100	FMO 101	FMO 102
					
Versions also in		-	-		
Protection class	IP 54	IP 54	IP 54	IP 54	IP 54
Typical application areas	For manual or semi-automatic filling in conjunction with drum and container pumps or for stationary use in plant engineering	For stationary use in plant engineering	For manual filling in conjunction with barrel and container pumps	For small flow rates and low filling quantity as well as precise dosing	For small flow rates and low filling quantity as well as precise dosing
Versions	In impulse version or with evaluation unit FLUXTRONIC®	With evaluation unit FLUXTRONIC®	With evaluation unit FLUXTRONIC®	In impulse version	In impulse version
Flow rate at viscosity < 5 mPas at viscosity > 5 mPas	10 - 100 l/min	25 - 250 l/min	10 - 100 l/min	0,09 - 1,67 l/min 0,04 - 1,67 l/min	0,44 - 8,3 l/min 0,25 - 8,3 l/min
Measurement error of the flow rate at viscosity < 5 mPas at viscosity > 5 mPas	+/- 1,5 %	+/- 1,5 %	+/- 1 %	+/- 2,5 % +/- 1 %	+/- 2,5 % +/- 1 %
Repeatability	+/- 0,15 %	+/- 0,3 %	-	+/- 0,03 %	+/- 0,03 %
Operating pressure max.	PP/ETFE: 4 bar S: 6 bar	PP/PVDF: 6 bar	PP: 4 bar	PVDF: 10 bar S: 100 bar	PVDF: 10 bar S: 100 bar
Viscosity max.	2.500 mPas	2.500 mPas	2.500 mPas	1.000 mPas	1.000 mPas
Material housing	PP, S, ETFE	PP, PVDF	PP	PVDF, S	PVDF, S
Material measuring chamber cpl.	PPS, ETFE	PE, PVDF	PPS	-	-
Material impellers	-	-	-	PPS, S	PPS, S
Material seals	EPDM, FKM, FEP, FFKM	EPDM, FKM	FKM	FKM, FFKM, EPDM	FKM, FFKM, EPDM
Advantages	<ul style="list-style-type: none"> ▶ Batch operation possible ▶ Insensitive to small solids ▶ Easy handling ▶ Easy assembly 	<ul style="list-style-type: none"> ▶ Batch operation possible ▶ Insensitive to small solids ▶ Easy handling ▶ Easy assembly 	<ul style="list-style-type: none"> ▶ Easy Handling ▶ Easy assembly ▶ Cheap alternative to FMC 100 	<ul style="list-style-type: none"> ▶ Batch operating possible ▶ Very precise dosing possible ▶ High resistancy ▶ Wide range of viscosities can be covered ▶ Low pressure loss 	<ul style="list-style-type: none"> ▶ Batch operating possible ▶ Very precise dosing possible ▶ High resistancy ▶ Wide range of viscosities can be covered ▶ Low pressure loss
Detailed information	Page 12-13	Page 12-13	Page 12-13	Page 14-15	Page 14-15

* Available on request: Blind cover version for FMO 140 and FMO 150

	Oval rotor principle				Turbine wheel principle
	FMO 104	FMO 110	FMO 140	FMO 150	FMT 120 PP
					-
	IP 54	IP 54	IP 54	IP 54	IP 65
	For the classic application with drum and container pumps as well as eccentric worm-drive pumps	For the classic application with drum and container pumps as well as eccentric worm-drive pumps	For use in plant engineering such as e.g. pipelines	For use in plant engineering such as e.g. pipelines	For small quantities with our pumps JUNIORFLUX/ COMBIFLUX
	In impulse version or with evaluation unit FLUXTRONIC®	In impulse version or with evaluation unit FLUXTRONIC®	With evaluation unit FLUXTRONIC®*	With evaluation unit FLUXTRONIC®*	-
	2 - 25 l/min 1 - 30 l/min	9,5 - 150 l/min 5,7 - 170 l/min	15 - 227 l/min 9,5 - 245 l/min	23 - 380 l/min 15 - 380 l/min	5 - 120 l/min
	+/- 2 % +/- 0,5 %	+/- 2 % +/- 0,5 %	+/- 1 % +/- 0,5 %	+/- 1 % +/- 0,5 %	+/- 1 %
	+/- 0,03 %	+/- 0,03 %	+/- 0,03 %	+/- 0,03 %	+/- 0,5 %
	AL: 130 bar S: 200 bar	PVDF: 10 bar AL: 130 bar S: 200 bar S Clamp: 16 bar	AL/S: 16 bar	AL/S: 16 bar	PP: 10 bar
	500.000 mPas	500.000 mPas	500.000 mPas	500.000 mPas	40 mPas
	S, AL	S, AL, PVDF	S, AL	S, AL	PP
	-	-	-	-	-
	PPS, S	PPS, S	PPS, S	PPS, S	PP
	FKM, FFKM, EPDM	FKM, FFKM, EPDM	FKM, FFKM, EPDM	FKM, FFKM, EPDM	PTFE
	<ul style="list-style-type: none"> ▶ Batch operating possible ▶ Very precise dosing possible ▶ High resistancy ▶ Wide range of viscosities can be covered ▶ Low pressure loss 	<ul style="list-style-type: none"> ▶ Batch operating possible ▶ Very precise dosing possible ▶ High resistancy ▶ Wide range of viscosities can be covered ▶ Low pressure loss 	<ul style="list-style-type: none"> ▶ Batch operating possible ▶ Very precise dosing possible ▶ High resistancy ▶ Wide range of viscosities can be covered ▶ Low pressure loss 	<ul style="list-style-type: none"> ▶ Batch operating possible ▶ Very precise dosing possible ▶ High resistancy ▶ Wide range of viscosities can be covered ▶ Low pressure loss 	<ul style="list-style-type: none"> ▶ Fast and safe calibration ▶ Displaying the subset and total amount
	Page 14-15	Page 14-15	Page 14-15	Page 14-15	Page 20

Note

You will find detailed information about batch operation and manual use on page 17. Impulse version: Suitable if external controls are to be used e.g. via an PLC or wall mounting of the evaluation unit FLUXTRONIC®.

Flow meters FMC/FMJ

built to the nutating disc principle

FLUX flow meters FMC, built to nutating disc principle, are designed for the use with FLUX drum pumps or for the stationary application e.g. in piping systems. With the evaluation unit FLUXTRONIC® filling and dosing processes of almost all kinds of fluids can be performed with maximum precision and highest safety. In automatic mode it is possible to output a signal for control purposes with the evaluation unit and the use of a switching amplifier. This way e.g. motor and / or magnetic valve and the most different processes can be controlled. The flow meter FMJ is a low-cost alternative, if only manual use is desired.

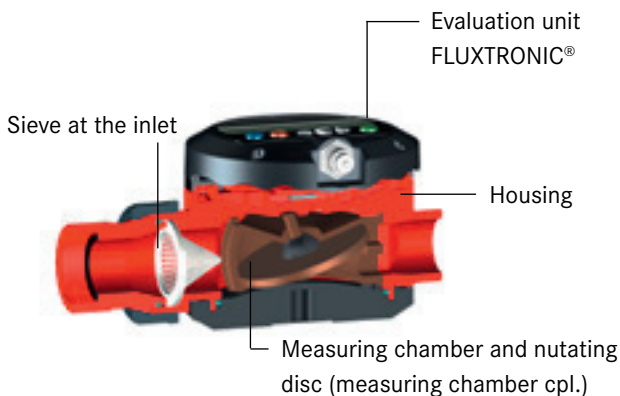

Advantages FMC 100/250

- ▶ Batch operation possible (automatic mode)
- ▶ High resistance
- ▶ Insensitive to small solids
- ▶ Easy handling
- ▶ Easy assembly
- ▶ FMC for use in hazardous areas 

Advantages FMJ 100

- ▶ Low-cost alternative to our FMC 100 if only manual use is desired

Functional description

The flow meters FMC 100/250 and FMJ 100 work on the nutating disc principle. Here, the liquid flow actuates the nutating disc. With a Reed sensor the number of rotations is counted and forwarded as an impulse or passed on to the evaluation unit FLUXTRONIC®. This calculates the flow quantity of the fluid based on the previously entered, medium dependent calibrating constant.

Product features

- ▶ Nutating disc principle
- ▶ For low viscosity media
- ▶ High measuring accuracy
- ▶ Easy calibration
- ▶ Reliable operation
- ▶ No mains connections required
- ▶ Signal transmission to evaluation unit FLUXTRONIC® or external control unit such as PLC possible
- ▶ Version also available for hazardous area 

Media examples

- ▶ Mineral oil
- ▶ Sulfuric acid up to 98 %
- ▶ Hydrochloric acid
- ▶ Phosphoric acid
- ▶ Formic acid



Semi-automatic filling with FMC 100 and switching amplifier FSV 100 from IBC.

Technical data	FMC 100	FMC 250	FMJ 100
Versions also in			
Protection class	IP 54	IP 54	IP 54
Application area	For manual or semi-automatic filling	For stationary use in plant engineering	For manual filling
Flow rate	10 - 100 l/min	25 - 250 l/min	10 - 100 l/min
Measurement error of the flow rate	+/- 1,5 %	+/- 1,5 %	+/- 1 %
Repeatability	+/- 0,15 %	+/- 0,3 %	-
Operating pressure max.	PP/ETFE: 4 bar S: 6 bar	PP/PVDF: 6 bar	PP: 4 bar
Viscosity max.	2.500 mPas	2.500 mPas	2.500 mPas
Material housing	Polypropylene, Stainless steel, Ethylene-tetrafluorethylene	Polypropylene, Polyvinylidene fluoride	Polypropylen

Note

The FLUX flow meter FMJ 100 is only for manual use with our drum pumps and can display the filled quantity with the evaluation unit FLUXTRONIC®. The FMJ is a low-cost alternative to our FMC 100, if only manual use is desired.



FMC 100 with switching amplifier FSV 100 installed in pipeline for semi-automatic filling.



FMC 100 in combination with air-operated diaphragm pump for manual use.



Classic drum pump application with flow meter FMJ 100, hose and hand nozzle for manual use.

Flow meter FMO

built to the oval rotor principle



The flow meter FMO built according to the oval rotor principle is suitable for measuring pure, thin to highly viscous media. With the evaluation unit FLUXTRONIC® filling and dosing processes of almost all kinds of fluids can be performed with maximum precision and highest safety. In automatic mode it is possible to output a signal for control purposes with the evaluation unit by using a switching amplifier. This way e.g. motor and / or magnetic valve and the most different processes can be controlled.



Functional description

The housing parts of the flow meters FMO form a measuring chamber in which the oval rotors mounted on axes can turn. The fluid flows through the measuring chamber and thus actuates the oval rotors. By the means of a Reed sensor the number of rotations is counted and forwarded as an impulse or passed on to the evaluation unit FLUXTRONIC®. This calculates the flown through quantity of the fluid based on the previously entered, medium-dependent calibrating constant.

Product features

- ▶ Oval rotor principle
- ▶ For thin to highly viscous pure media
- ▶ Available with integrated evaluation unit FLUXTRONIC® or as impulse version for the use in piping systems
- ▶ Depending the type for use with drum pumps or eccentric worm-drive pumps
- ▶ High accuracy and repeat accuracy
- ▶ Signal can be forwarded to FLUXTRONIC® or another external control as e.g. PLC
- ▶ Can be used for ex-applications in Zone 1 
- ▶ Also available with FOOD and FDA certification  

Media examples

- ▶ Oils
- ▶ Gasoline
- ▶ Solvents
- ▶ Not self-lubricating media
- ▶ Grease

Advantages

- ▶ Batch operation possible (automatic mode)
- ▶ Very precise dosing possible
- ▶ High resistance
- ▶ Wide range of viscosities can be covered
- ▶ Can also be used for pulsating volume flows
- ▶ Low pressure loss
- ▶ Versions also available for hazardous areas 



FMO 150 with flange connection installed in a pipeline.

Technical data						
	FMO 101	FMO 102	FMO 104	FMO 110	FMO 140	FMO 150
Versions also in						
Protection class	IP 54					
Application areas	For manual or semi-automatic filling		For manual or semi-automatic filling		For stationary use in plant engineering such as e.g. pipelines	
Flow rate						
at viscosity < 5 mPas	0,09-1,67 l/min	0,44-8,3 l/min	2-25 l/min	9,5-150 l/min	15-227 l/min	23-380 l/min
at viscosity > 5 mPas	0,04-1,67 l/min	0,25-8,3 l/min	1-30 l/min	5,7-170 l/min	9,5-245 l/min	15-380 l/min
Measurement error of the flow rate						
at viscosity < 5 mPas	+/- 2,5 %		+/- 2 %		+/- 1 %	
at viscosity > 5 mPas	+/- 1 %		+/- 0,5 %		+/- 0,5 %	
Repeatability	+/- 0,03 %					
Operating pressure max.	PVDF: 10 bar S: 100 bar		S: 200 bar AL: 130 bar	PVDF: 10 bar AL: 130 bar S: 200 bar S Clamp: 16 bar	S/AL: 16 bar	
Viscosity max.	Up to 1.000 mPas		Up to 1.000 mPas From 1.000 to 500.000 mPas			
Material housing	Stainless steel, Polyvinylidene fluoride		Stainless steel, Aluminium	Stainless steel, Aluminium, Polyvinylidene fluoride	Stainless steel, Aluminium	

Note

The flow meters FMO can be arranged in any vertical position (fig. 1). The alignment of the axes of the oval rotors must be done as shown in fig. 2.

Any orientation

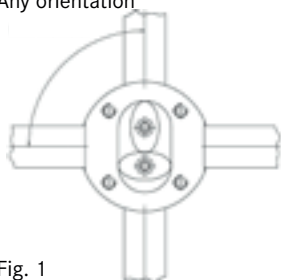

Fig. 1

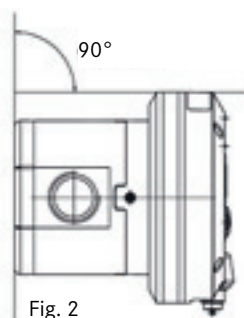

Fig. 2

Oval rotors up to 1.000 mPas



Oval rotors from 1.000 to 500.000 mPas



Classic drum pump application with flow meter FMO 104, switching amplifier FSV 100, hose and hand nozzle for a semi-automatic filling.

Evaluation unit FLUXTRONIC®

in combination with flow meters FMC, FMJ and FMO

With the evaluation unit FLUXTRONIC® for FMC/FMJ and FMO filling and dosing processes of almost all kinds of fluids can be performed with maximum precision and highest safety. There are two operating options. While in "normal mode" only the passed through volume is displayed, in "automatic mode" it is possible to fill pre-programmed quantities semi-automatically at the push of a button. As soon as the requested quantity is filled it is possible to output two signals. This way, e.g. a valve or a drive motor can be controlled or the signal is forwarded to a PLC.



Advantages

- ▶ Simple operating concept with intuitive menu navigation
- ▶ All data will be maintained when replacing the battery due to currentless memory
- ▶ Can also be operated with protective gloves
- ▶ 4 safety levels with PIN settings
- ▶ Special cancel key / Exit
- ▶ No double assignment of the keys with different functions
- ▶ No time delay during key operation
- ▶ 5 signal outputs provide additional security and comfort
- ▶ Also explosion-proof for use in zone 1



Technical data FLUXTRONIC®

Ambient temperature	-20 to +40 °C (at temp. below 0 °C the LCD-display is slowed)
Housing material	PP
Pulse length	2 ms
Power supply	Lithium battery CR 2032
Protection class	IP 54
Input	Mechanical contact (REED sensor) start/stop (button)
Output	NAMUR: redirection, signal 1 – e. g. for motor, signal 2 – e. g. for valve, error signal OK signal
Ex-marking	II 2G Ex ia IIB T6 Gb 

Product features

- ▶ Mounting on flow meter, hand nozzle or wall possible
- ▶ Calibration on medium possible
- ▶ Display in liters, gallons or kilograms possible (normal mode)
- ▶ Batch operation with switching amplifier possible (automatic mode)
- ▶ Menu navigation through display symbols



Evaluation unit FLUXTRONIC® mounted on flow meter or directly on hand nozzle.

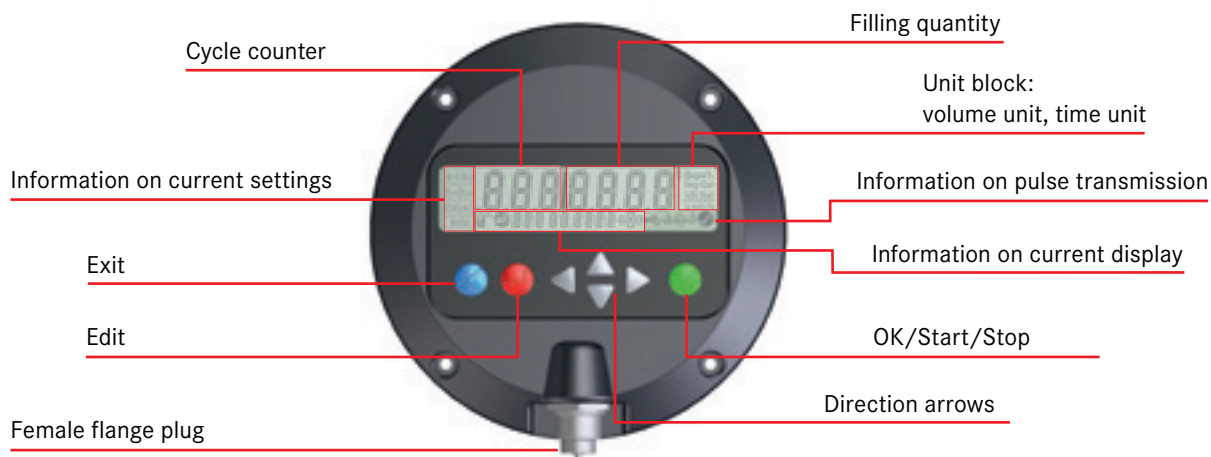

Comparison normal and automatic mode

The well-proven FLUX flow meters FMC/FMJ or FMO, in combination with the specially adapted FLUX drum and container pumps, application-specific designed motor, hose line and an discharge fitting, offer you everything that you need for fast and safe emptying of various containers. Basically, there are two different operation modes of the electronics available:

Normal mode (manual use)	Automatic mode (batch operation)
<p>In normal mode all incoming impulses are counted and displayed. There are no valves activated. This operation mode is suitable for a simple filling task. Additionally, a total quantity display is available. For normal mode no additional devices are required .</p>	<p>The automatic mode is suitable to fill the same quantities (which can be pre-set) automatically at the push of a button. Here, further devices such as amplifier and valves (solenoid valves) are required. Two control signals are available that start at the same time but might end with a time delay.</p> <p>Examples:</p> <ul style="list-style-type: none"> ▶ Pump motor is switched off before a solenoid valve is closed → higher filling accuracy ▶ Solenoid valve with large cross-section is closed before one with a smaller cross-section → higher filling accuracy with fast filling process. <p>As in normal operation a total quantity display is also available in automatic mode. Additionally, a cycle counter is integrated which then registers and adds up complete filling processes.</p>

Flow meters FMC and FMO as part of semi-automatic filling systems

FLUX semi-automatic filling systems allow pre-set quantities to be quickly and safely metered at the touch of a button. They provide an economical alternative to conventional automatic filling systems and stations. The combination of pump, motor, flow meter and additional accessories is designed for the specific application, it can also be configured for ex-applications. In order to configure a semi-automatic filling system, it is essential to follow the correct procedure. The following instructions show the individual steps for an example in the non-ex-area (below) and an example in the ex-area (see following page).

Systematic procedure for selecting the components:

- | | |
|---|------------|
| 1. Select the components following the flow path of the liquid from the container to the discharge fitting. | 1 1 to 5 5 |
| 2. Find any missing connecting elements. | 6 6 |
| 3. Decide on the electrical components to be used for the control system. | 7 7 to 8 8 |
| 4. In the case of applications within the ex-area, check compliance with the ex-rules as specified by the operator. | 9 |

Note

The designs shown in the following examples incorporate various FLUX discharge fittings. However, depending on the medium and application, other configurations may also be recommended which include a hand nozzle and integrated electronic display unit, or a discharge spout. Just contact your FLUX sales engineer for advice.

Configuration example showing a semi-automatic filling system for the non-ex-area

- 1 Pump (non-return valve recommended)
- 2 Motor without undervoltage protection
- 3 Flow meter with electronic display unit FLUXTRONIC®
- 4 Hose
- 5.1 FLUX hand nozzle
- 5.2 FLUX discharge unit with spring valve (FAE)
- 5.3 FLUX discharge fitting with externally controlled valve
- 6 Connecting elements
- 7 Integrated switching amplifier
- 8 External Start-Stop
- 9 Control and mains cable (--- in figure)

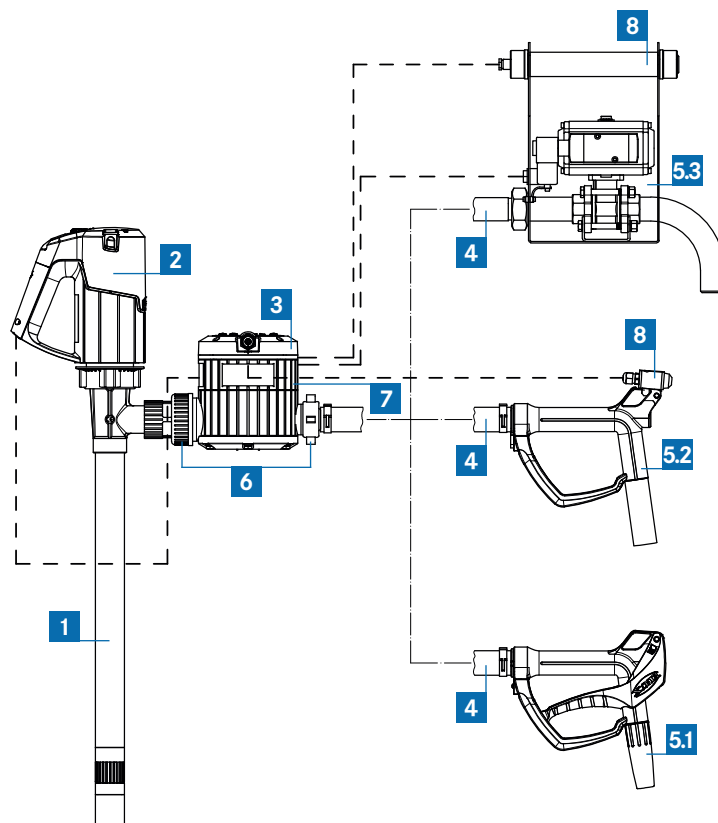

Selection of the individual components and illustrative selection criteria

- | | |
|--|---|
| <p>1 1 Pump</p> <ul style="list-style-type: none"> ▶ Application (type, immersion depth, non-return valve yes/no, Ex yes/no) ▶ Medium (material) <p>2 2 Motor without undervoltage protection</p> <ul style="list-style-type: none"> ▶ Type (electric, compressed-air, Ex yes/no) ▶ Desired flow rate (output) <p>3 3 Flow meter</p> <ul style="list-style-type: none"> ▶ Application (type, Ex yes/no, with electronic display unit FLUXTRONIC® or external signal processing) ▶ Desired flow rate (design size) ▶ Medium (material) <p>4 4 Hose</p> <ul style="list-style-type: none"> ▶ Application (Ex yes/no) ▶ Medium (material, resistance, FOOD) <p>5 5 FLUX discharge fitting</p> <ul style="list-style-type: none"> ▶ Application ▶ Filling accuracy ▶ Ease of use ▶ Medium (material) | <p>6 6 Any missing non-electrical connecting components</p> <ul style="list-style-type: none"> ▶ Component fittings (any required hose connection) <p>7 7 Switching amplifier</p> <ul style="list-style-type: none"> ▶ Non-ex application (integrated within flow meter or remote mounted) ▶ Ex-application (not integrated, placement within ex-area possible) <p>8 8 External start/stop control</p> <ul style="list-style-type: none"> ▶ Wired-in <p>9 9 Control and mains cable</p> <ul style="list-style-type: none"> ▶ Application (Ex yes/no) ▶ Positioning of the components <p>10 Earth cable for equipotential bonding</p> <ul style="list-style-type: none"> ▶ For ex-applications |
|--|---|

Configuration example showing a semi-automatic filling system for the ex-area



- 1** Pump (non-return valve recommended)
- 2** Motor without undervoltage protection
- 3** Flow meter with electronic display unit FLUXTRONIC®
- 4** Hose
- 5.1** FLUX hand nozzle
- 5.2** FLUX discharge unit with spring valve (FLUX filling unit FAE)
- 5.3** FLUX discharge fitting with externally controlled valve
- 6** Connecting elements
- 7** Switching amplifier
- 8** External start/stop control
- 9** Control/mains cable (---in Figure)
- 10** Earth cable

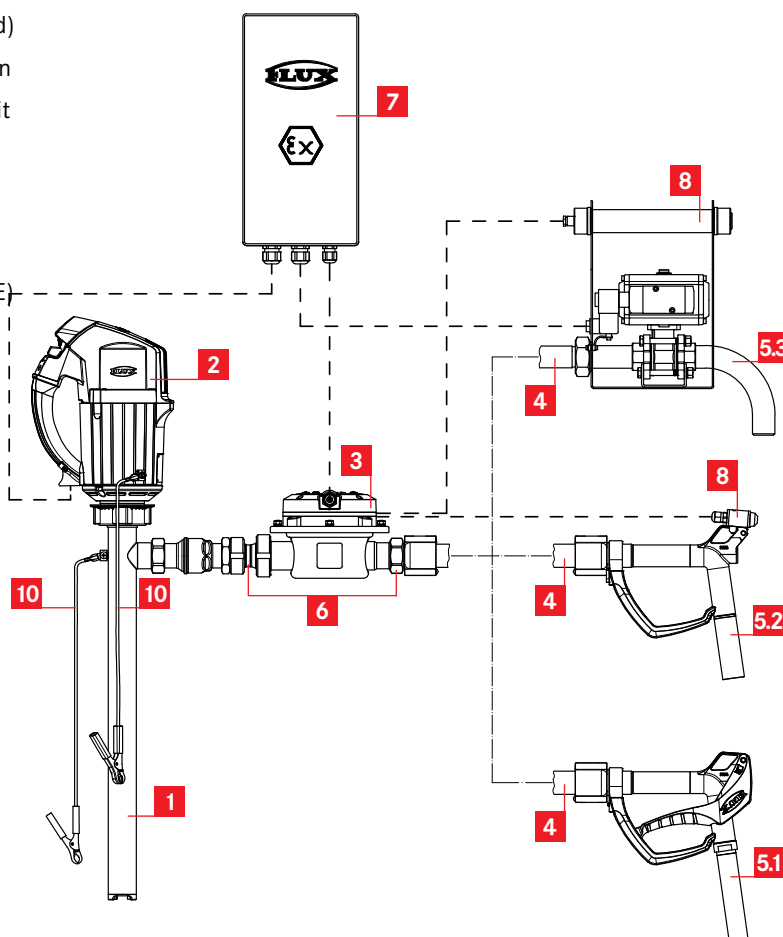

Flow meter FMT 120 PP

built to turbine wheel principle

The FLUX flow meter FMT 120 PP works on the turbine wheel principle and is an economical alternative to our flow meters FMO and FMC / FMJ. The FMT 120 PP is easy to handle and allows a fast and safe filling of media.



FMT 120 PP with illuminated display.

Technical data

	FMT 120 PP
Protection class	IP 65
Application areas	For manual filling
Flow rate	5 - 120 l/min
Measurement error of the flow rate	+/- 1 %
Operating pressure max.	10 bar
Viscosity max.	40 mPas
Material housing	PP

Functional description

The turbine meter FMT 120 PP consists mainly of a turbine wheel freely rotating in the liquid flow. The medium flowing in the flow meter makes the turbine wheel turn, this is measured and evaluated. The evaluation of the partial and total quantity is made via an illuminated two-line display.

Product features

- ▶ Cost effective turbine wheel flow meter
- ▶ Suitable for pure and low-viscosity media
- ▶ Symmetrical measuring chamber
- ▶ Fast and safe filling of liquids
- ▶ User-friendly handling
- ▶ Two-line LED display

Advantages

- ▶ Long-live lithium battery
- ▶ Fast and safe calibration
- ▶ Displaying the subset and total amount
- ▶ Use for all flow directions

Media examples

- ▶ Aggressive media
- ▶ Low-viscosity media
- ▶ Neutral media
- ▶ Non-flammable media

FLUX offers more than just pumps. As well as a great diversity of pumps and suitable motors FLUX has an extensive range of ancillary products and accessories. After the analysis of the problem by FLUX consultant complete customized solutions are developed. These can extend from small-scale product configurations through to complex systems.

Task:

Filling of 10, 20 and 60 litre cans and 200 l drums from IBC stacked or on racking.

Material: Mineral oils and machining oils.



Solution features

- ▶ Quantity to be filled is pre-set via FLUXTRONIC®
- ▶ Filling is started by pressing a button on the discharge unit

Components

- ▶ Drum pump F 430 S TR
- ▶ Commutator motor F 457
- ▶ PVC hose
- ▶ Flow meter FMC 100 in stainless steel with electronic evaluation unit FLUXTRONIC®
- ▶ 2-way valve
- ▶ Switching amplifier FSV 100 for controlling the motor and 2-way valve
- ▶ Mineral oil hose integrated
- ▶ Wired in discharge unit
- ▶ Stainless steel panel (mounted on the struts of the IBC)

Task:

Filling of highly toxic media.



Solution features







- ▶ Personnel and environment are protected from toxic vapours
- ▶ Almost no medium whatsoever is left in the drum

Components

- ▶ Drum pump FP 425 S in stainless steel for 99.98 % drum emptying
- ▶ Commutator motor F 457 EL
- ▶ Flow meter FMC 100 in stainless steel with electronic evaluation unit FLUXTRONIC®
- ▶ Discharge unit with electro-pneumatic 2-way valve
- ▶ Switching amplifier FSV 100 to control the motor and 2-way valve
- ▶ Emission protection valve for drum pump
- ▶ Emission protection cone for drum being filled

Accessories for flow meters

With the right accessories to a semi-automatic filling system

Accessories	Function	Picture	Part number
Impulse cable	For flow meters FMO 104/110 in impulse version. <ul style="list-style-type: none"> ▶ 2-core ▶ both sides with wire sleeves ▶ insulated to transmit control signal from FMO reed-relais to the external evaluation display FLUXTRONIC® ▶ 5 m, 10 m, 15 m 		10-934 08 032 10-934 08 033 10-934 08 034
Earth-wire	For FMC PP and FMC ETFE. <ul style="list-style-type: none"> ▶ to produce a conductive connection of hose and motor 		10-931 90 009
Switching amplifier FSV 100	Switching amplifier for installation in flow meters with two control signals. <ul style="list-style-type: none"> ▶ Can be integrated in FMO / FMC between measuring unit and display electronic ▶ 230 V, 50-60 Hz, IP 44, 4 A ▶ 100-120 V, 50-60 Hz, IP 44, 8 A ▶ Connection cable for switching amplifier/ motor 0,5 m 		10-001 49 040 10-001 49 046
Connection cable for switching amplifier/ magnetic valve	For switching amplifier FSV 100. <ul style="list-style-type: none"> ▶ 5 m 		10-934 08 036
Switching amplifier FSV 132	Switching amplifier without housing for installation in switch box. <ul style="list-style-type: none"> ▶ Two signals ▶ 230 V, 50 - 60 Hz, IP 20, AC 4 A, DC 2 A ▶ With Ex-input for use outside of hazardous areas ▶ Ex II (1) [Ex ia Ga] IIC 		10-940 04 020
5-core control cable	For the connection with flow meter or FAE. <ul style="list-style-type: none"> ▶ 5 m, 10 m, 15 m 		10-934 08 038 10-934 08 040 10-934 08 041

Accessories	Function	Picture	Part number
Switching amplifier FSV 133 Ex 	Switching amplifier without housing for installation in switch box. ▶ One signal ▶ Electronic exit 35 V DC/50 mA ▶ DC supply 24 V ▶ Rated current 50 mA ▶ With Ex-input for use outside of hazardous areas according to EN 60947-5-6 ▶ Ex II 3 (1) G Ex nAc cCc [ia] IIC T4		10-940 04 041
5-core control cable	For the connection with flow meter or FAE ▶ 5 m, 10 m, 15 m		10-934 08 038 10-934 08 040 10-934 08 041
Switching amplifier FSV 121 Ex 	Switching amplifier for wall mounting with one control signal. ▶ With control cable, 5 m long, for transmission of the control signals of the flow meter ▶ With miniCLIX connectors for network connection cable and connection cable 5 m ▶ One signal ▶ 120-230 V, 50-60 Hz, IP 66, 4A ▶ Ex version for zone 1 ▶ Ex II 2 G db eb [ia Ga] IIC T6 Gb		10-001 49 051
Power supply cable	For switching amplifier. ▶ 5 m with plug-in		10-934 08 048
Connection cable	For motor or magnetic valve. ▶ 5 m		10-934 08 049
Switching amplifier FSV 121-1/2 Ex 	Switching amplifier for wall mounting with one or two signals. ▶ Without plug connection and control cable ▶ 121-1: One signal, 120-230 V, 50-60 Hz, IP 66, 4A ▶ 121-2: Two signals, 120-230 V, 50-60 Hz, IP 66, 4A ▶ Ex version for zone 1 ▶ Ex II 2 (1) G Ex db eb [ia Ga] IIC T6 Gb		10-001 49 039 10-001 49 063
5-core control cable	For the connection with flow meter or FAE. ▶ 5 m, 10 m, 15 m		10-934 08 038 10-935 08 040 10-934 08 041



More than just pumps

Today the FLUX name is recognised around the globe as the trademark for top standards in pump technology. Everything started with the invention of the electric drum pump in 1950. Nowadays FLUX has an extensive range of products each of which can be customized. FLUX pumps are used for example in the chemical and pharmaceutical industries; in machinery and plant engineering as well as companies in electroplating, wastewater treatment and the food sector.

Whether single-product or system solution – FLUX quality is synonymous with a long service life, excellent economy and maximum safety.

In addition to the excellent product quality FLUX customers appreciate the superb level of expertise our staff has to offer as well as their genuine customer focus.

These days FLUX-GERÄTE GMBH supplies pumps to almost 100 countries around the globe.